



AS-200T

AS PPH Odwodnienia Liniowe Sp. z o.o.
ul. Urbanistów 1, 05-500 Piaseczno
tel./fax (022) 737 05 23
e-mail: biuro@aspvh.pl
www.aspvh.pl

Pozycja CT Korytka o szerokości wewnętrznej 200mm

CT.II.	Numer elementu	KORYTKA AS-200T	Szerokość mm	Wysokość mm	Długość mm	Przekrój poprzeczny cm ²	Powierzchnia wlotowa cm ² /mb	Masa kg	Ruszty żeliwne
CT.II.1.	1.1	bez spadku	262	320	665	448	879	57.0	Ruszty żeliwne kl.C 250 - 8.0 kg kl.D 400 - 10.0 kg
CT.II.2.	2.1	bez spadku	262	200	665	208	879	45.0	
CT.II.3.	0.1.1	górný element studzienki	262	320	665	448/950*	879	37.0	
CT.II.4.	0.2.1	górný element studzienki	262	200	665	208/950*	879	25.0	
CT.II.5.	-	dekiel z odpływem nr 1.1	262	320	-	-	-	7.6	
CT.II.6.	-	dekiel z odpływem nr 2.1	262	200	-	-	-	4.8	
CT.II.7.	-	dekiel ślepy nr 1.1	262	320	-	-	-	8.0	
CT.II.8.	-	dekiel ślepy nr 2.1	262	200	-	-	-	5.0	
C.IV.	Numer elementu	ELEMENTY STUDZIENKI	Szerokość mm	Wysokość mm	Długość mm	Masa mm			
C.IV.1.	A	przelotowy bez odpływu	292	320	680	61.9			
C.IV.2.	A	przelotowy z odpływem z boku	292	320	680	60.4			
C.IV.3.	A	przelotowy z odpływem czołowym	292	320	680	60.4			
C.IV.4.	B	z dnem, bez odpływu	292	330	680	77.6			
C.IV.5.	B	z dnem, z odpływem z boku	292	330	680	76.1			
C.IV.6.	B	z dnem, z odpływem czołowym	292	330	680	76.1			
C.IV.7.		łapacz zanieczyszczeń	170	250	400	3.8			

* powierzchnia wlotu do studzienki



AS-200T

AS PPH Odwodnienia Liniowe Sp. z o.o.
ul. Urbanistów 1, 05-500 Piaseczno
tel./fax (022) 737 05 23
e-mail: biuro@aspgh.pl
www.aspgh.pl

CT.II.

Korpus korytka

PN-EN 1433:2005

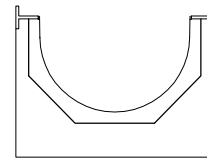
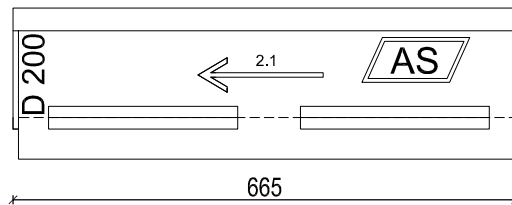
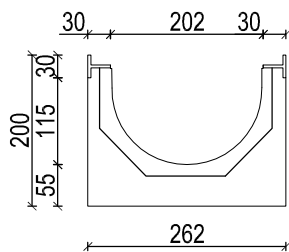
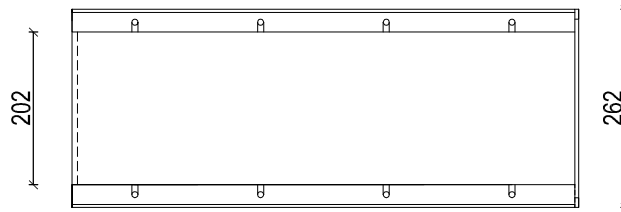
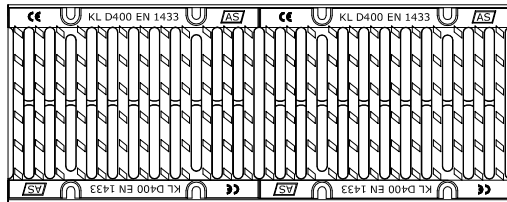



AS-200T

AS PPH Odwodnienia Liniowe Sp. z o.o.
ul. Urbanistów 1, 05-500 Piaseczno
tel./fax (022) 737 05 23
e-mail: biuro@aspgh.pl
www.aspgh.pl

CT.II.

Korpus korytka

PN-EN 1433:2005

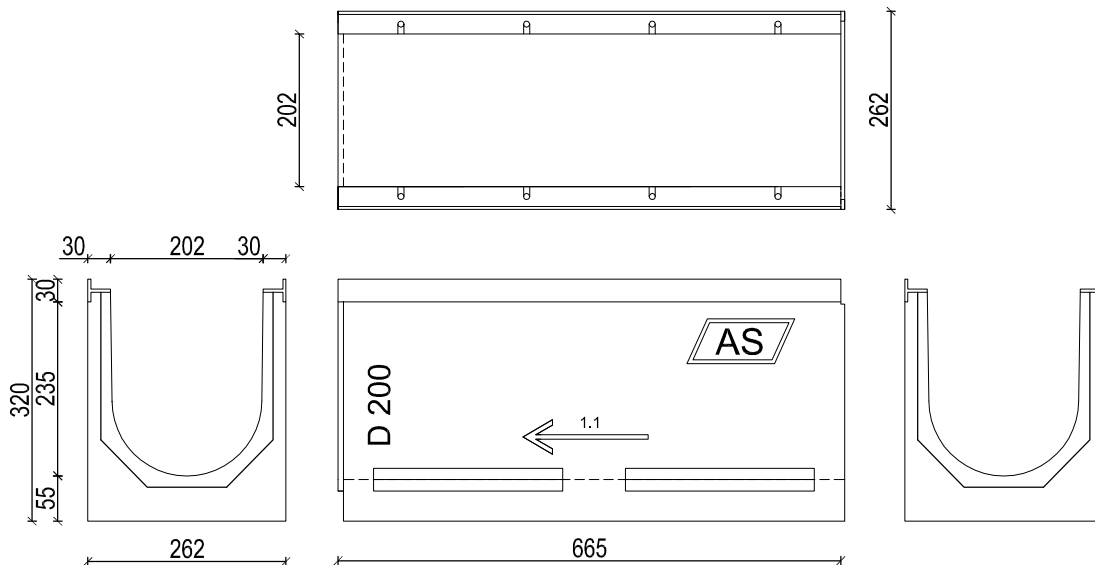
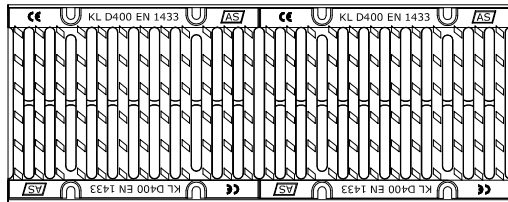



AS-200T

AS PPH Odwodnienia Liniowe Sp. z o.o.
ul. Urbanistów 1, 05-500 Piaseczno
tel./fax (022) 737 05 23
e-mail: biuro@aspgh.pl
www.aspgh.pl

CT.II. C.IV.

Studzienki

PN-EN 1433:2005

górnny element studzienki

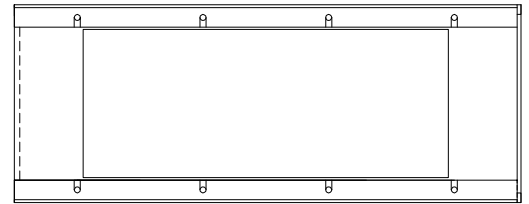
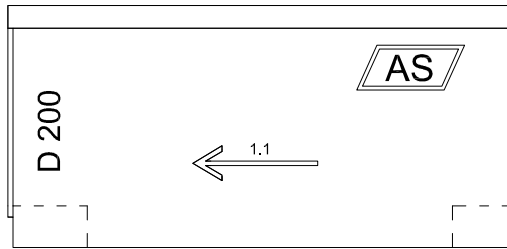
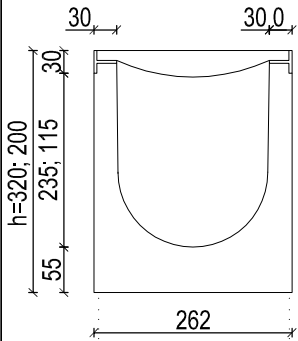

element przelotowy

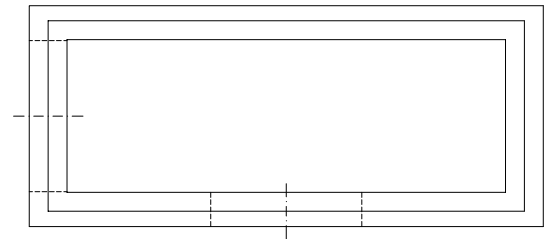
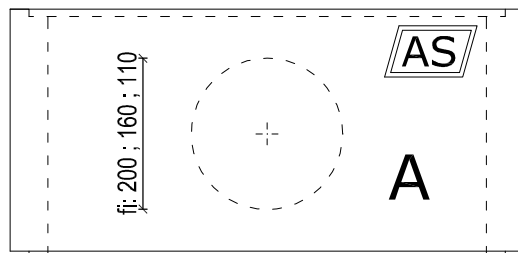
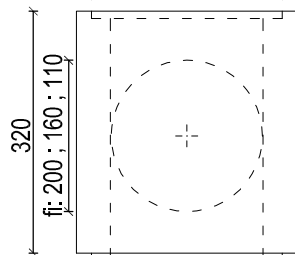

łapacz zanieczyszczeń

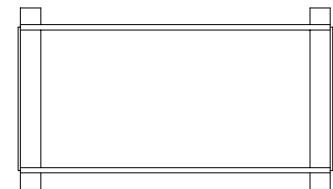
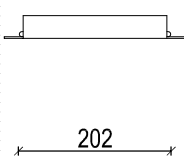
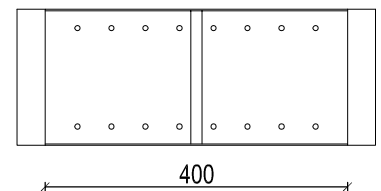
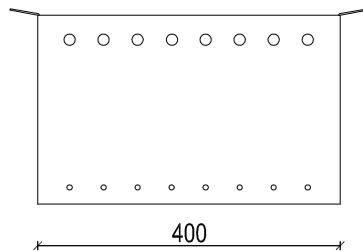
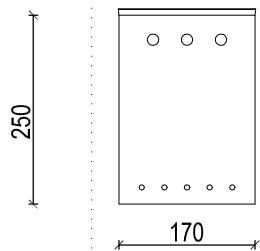

element z dnem

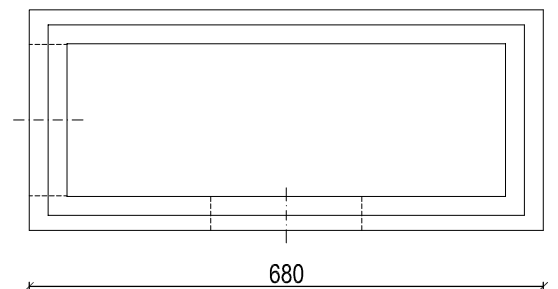
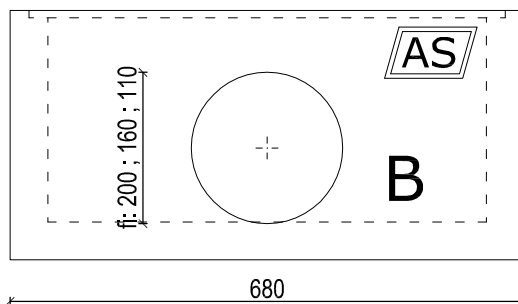
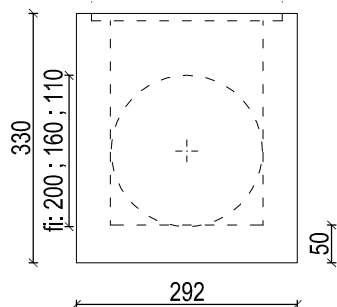

SKALA 1:10